

BOB DILDINE

# LET TIME DOMAIN RESPONSE PROVIDE ADDITIONAL INSIGHT INTO NETWORK BEHAVIOR

Doug Rytting  
Network Measurements Division  
1400 Fountain Grove Parkway  
Santa Rosa, California 95401

**RF & Microwave  
Measurement  
Symposium  
and  
Exhibition**



**HEWLETT  
PACKARD**

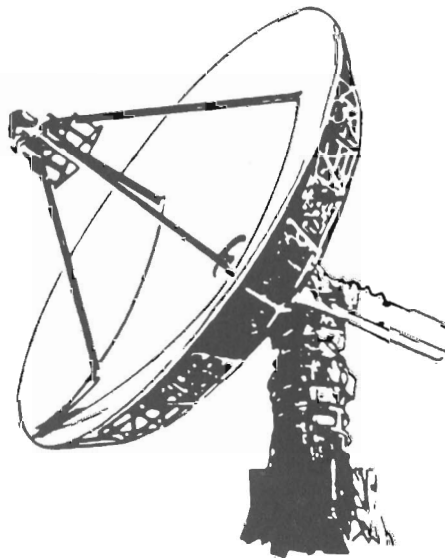

# TIME DOMAIN OUTLINE OF MATERIAL

- I. Time Domain Introduction
- II. Basic Time Domain
- III. Advanced Time Domain
- IV. Application Examples

2532

## I. TIME DOMAIN INTRODUCTION

### Topics in This Section

- Theory of Simple TDR
- Reflections from Simple Networks
- Effects of Finite Risetime
- TDR Using Inverse Fourier Transform

2533

In the early 1960's, the technique of time domain reflectometry was introduced. This technique involved the generation of a voltage step in time that was propagated down a transmission line: a reflection from an impedance was detected on an oscilloscope and, by measuring the ratio of the input voltage to the reflected voltage, the impedance of simple discontinuities could be calculated.

*David*

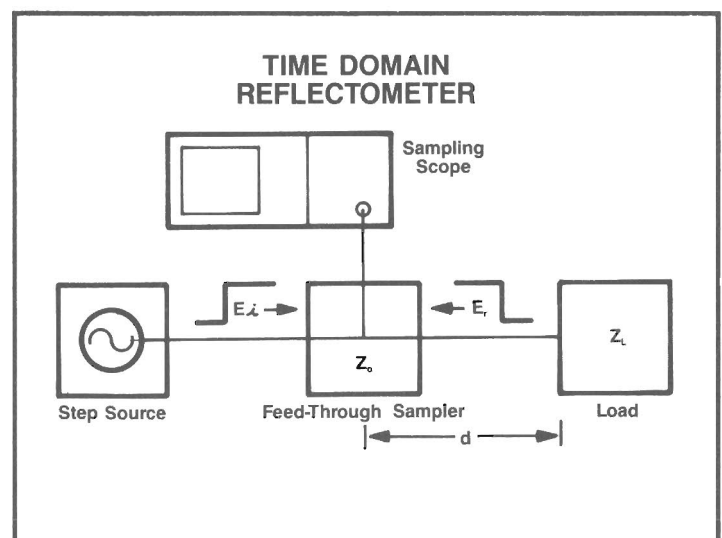

2534

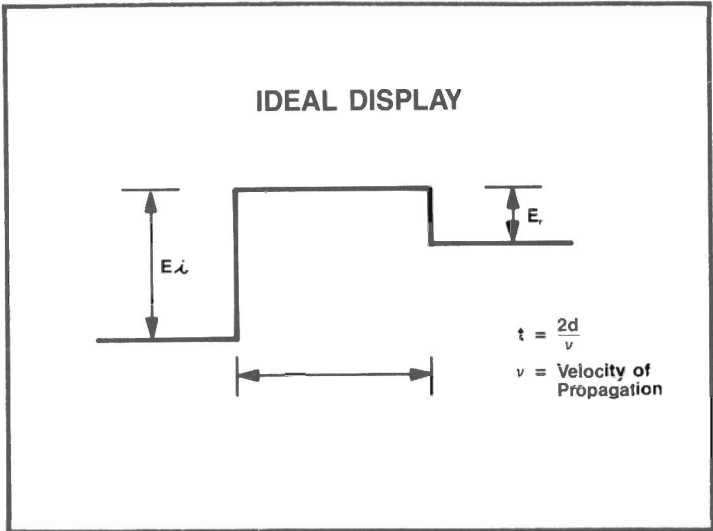

2535

Operator determined the distance to a discontinuity or the distance between two discontinuities by measuring them as a function of time and by knowing the velocity of propagation along the transmission line.

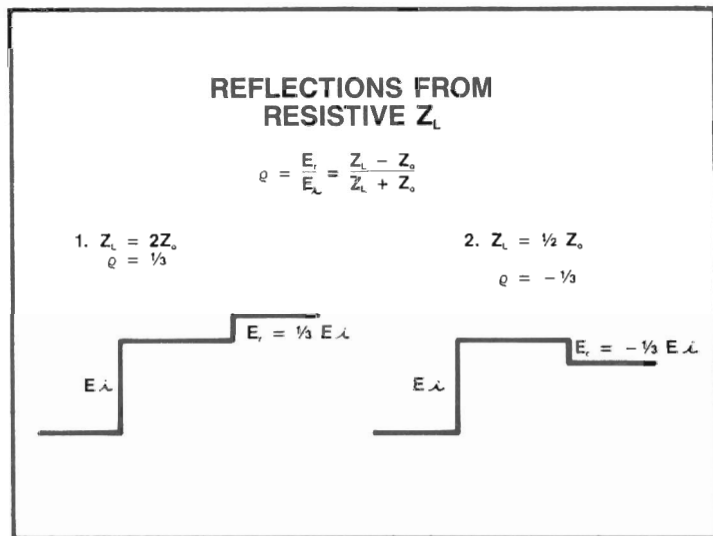

2536

This slide illustrates typical responses for terminating impedances of twice or one-half the characteristic impedance of a transmission line.

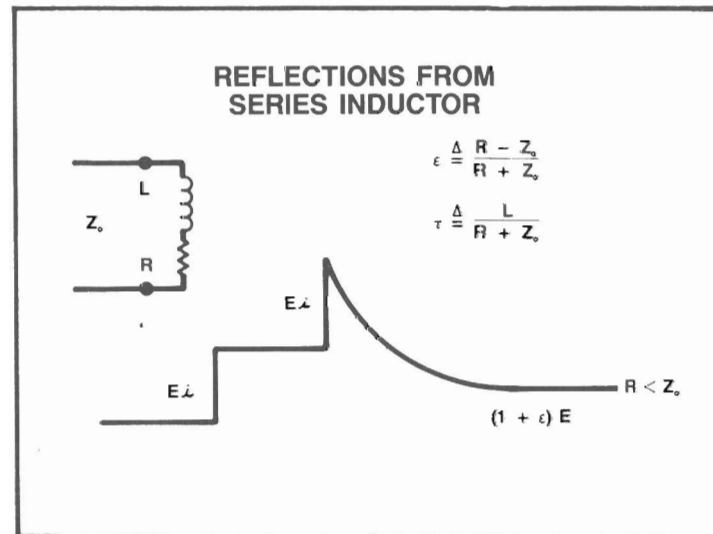

2537

Adding reactive elements to simple resistive terminations results in more complex displays. For example, if the terminating load is an inductor and a resistor, the wave form shows an initial spike due to the high frequency reactance of the inductor with an exponential fall off to a final value determined by the resistor.

Similarly, the response to a terminating impedance that has a shunt capacitance is illustrated.

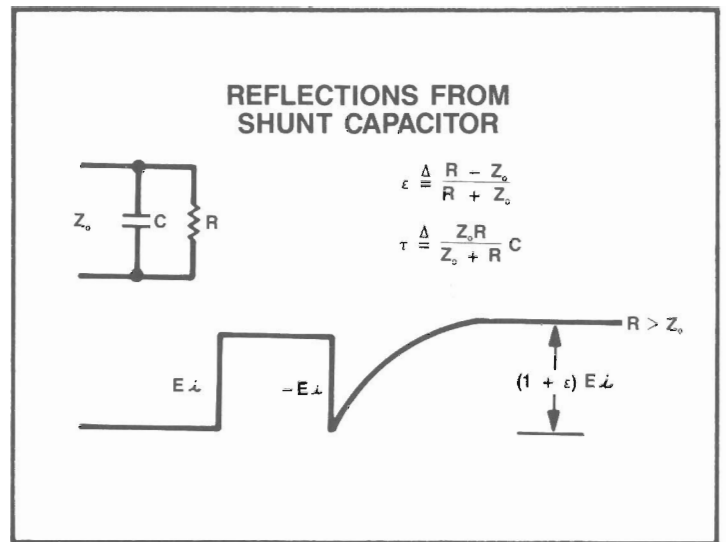

2538

Moving from the ideal response to practical applications, we can examine the effect of a finite rise time on a small inductor that is in series with the load. This equation determines the reflection coefficient.

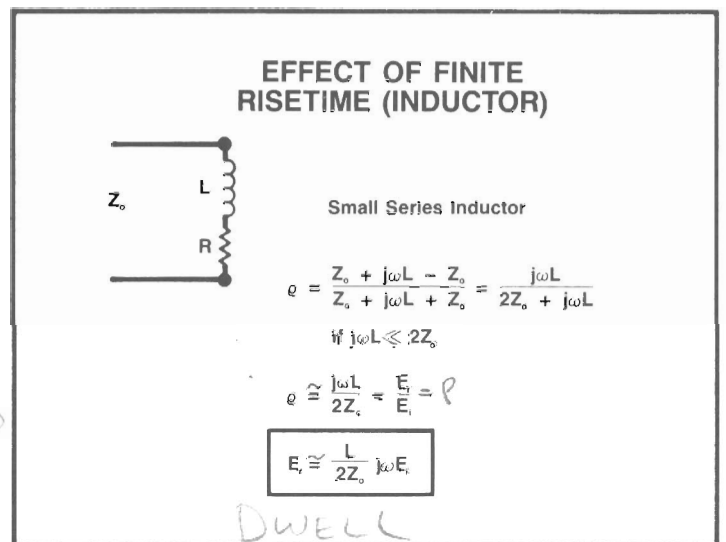

2539

By measuring both the rise time of the pulse in volts per second and the response to the load, we can calculate the series inductance value.

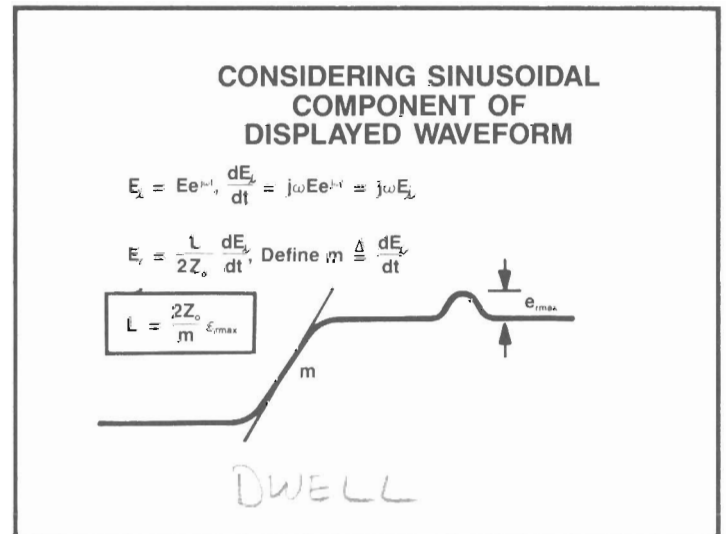

2540

MOVING FROM IDEAL TO PRACTICAL

EFFECT OF FINITE RISE TIME

REFLECTION COEF. AS A FUNCTION OF  $\omega$

- DIFFERENTIATING INCIDENT STEP

- RECALL EXPRESSION FOR  $E_r$

- DEFINE SLOPE

- L

- SIMILAR DERIVATION FOR C

## LIMITATIONS OF TRADITIONAL TDR

1. Rise Time
2. Sampling Scope Sync. Jitter
3. Poor Signal-to-Noise Ratio
4. Large E<sub>i</sub> May Damage Active Devices
5. Needs DC Path

2541

### TDR USING INVERSE FOURIER TRANSFORM

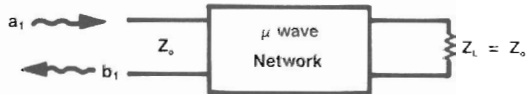

1 - Freq. (Measured)	2 - Time (Calculated)
$S_{11}(\omega) = \frac{b_1}{a_1} \Big _{Z_L = Z_0}$	$S_{11}(t) = \mathcal{F}^{-1} S_{11}(\omega)$
$b_1(\omega) = S_{11}(\omega) a_1(\omega)$	$b_1(t) = \mathcal{F}^{-1} S_{11}(\omega) * a_1(\omega)$
	$b_1(t) = S_{11}(t) * a_1(t)$
	convolved
$a_1(\omega) = \sim \text{Sinewave}$	$a_1(t) = \begin{cases} \text{Impulse or} \\ \text{Step (TDR)} \end{cases}$

2542

### 8510 TIME DOMAIN CAPABILITIES

1. Frequency Data from 45 MHz to 26.5 GHz
2. Choice of Number of Points from 51 to 401
3. Conversion Speed from 100 to 600 msec *SKIP*
4. Choice of Time Stimulus (Impulse or Step)
5. Gating to Remove Unwanted Time Responses  $\rightarrow$  *FREQ DOM.*
6. Improved Signal-to-Noise Ratio
7. Does Not Require DC Path

2543

While the traditional TDR was useful as a qualitative tool, the limitations listed on the slide affected its accuracy and utility.

In the early 1970's, it was shown that the Fourier Transform of the network reflection coefficient as a function of frequency is the reflection coefficient as a function of time; i.e., the distance along a transmission line.

*DWAL*

A high performance vector network analyzer combined with fast computation power has created unique measurement capabilities in the 8510.

Using error corrected data measured in the frequency domain, the response of a network to step and impulse time stimuli can be calculated and displayed as a function of time.

This gives traditional Time Domain Reflectometry capability in reflection and transmission and adds measurement potential in frequency band limited networks.

By locating network elements in time and removing their effects from measured data, the 8510 makes more precise frequency domain measurements possible.

## II. BASIC TIME DOMAIN

### Topics in This Section

- Low Pass & Band Pass Modes
- Step & Impulse Stimulus
- Windowing
- Theoretical Time Domain Examples

2544

The low pass mode simulates a traditional TDR. The frequencies must be harmonically related, and a value for the DC term must be estimated. The data at DC is extrapolated from the data of the first few harmonics. Since there is a DC term, step excitation is valid in the low pass mode.

LOW PASS MODE: DATA  $\pm$   
AROUND DC

-DC DATA EXTRAPOLATED

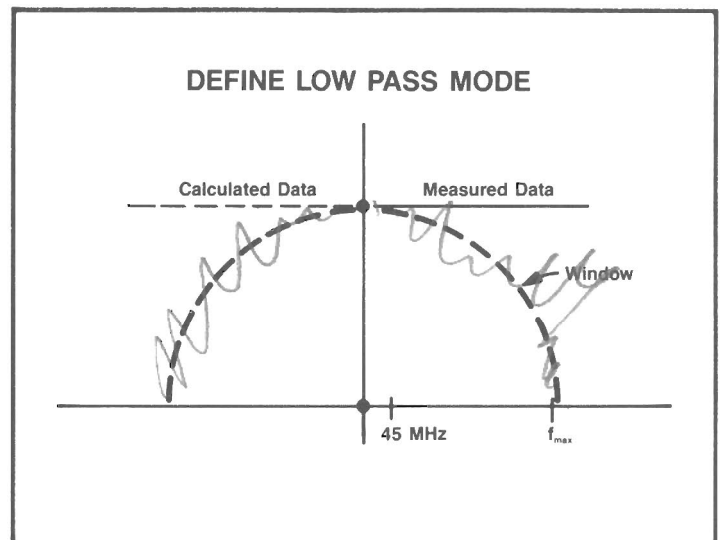

2545

The band pass mode simulates a narrow-band TDR. This mode is very good for fault location and transmission measurements. Also, it is the only mode that can be used over an arbitrary set of start and stop frequencies. Since the band pass mode does not include a DC value, only the impulse excitation is used.

BAND PASS MODE:

-BAND LIMITED DATA

NO DC

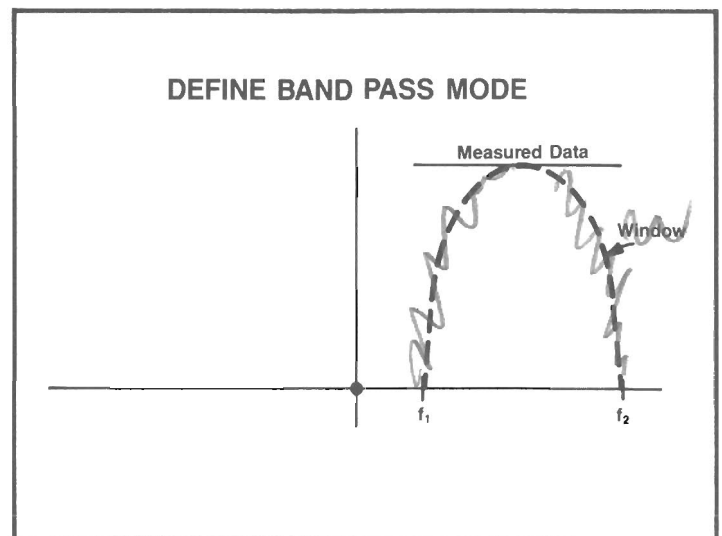

2546

## DEFINE STEP & IMPULSE STIMULUS

STEP 

IMPULSE 

1. Must Be Used for Traditional TDR
2. Only Used in Low Pass
3. Identifies Pos. & Neg. Impedance Easily

1. Good for Trans. & Fault Loc.
2. Used in Low Pass & Band Pass
3. Difficult to Determine Type of Impedance

2547

Low pass mode can support both step and impulse excitation. The band pass mode only supports impulse excitation. Both these stimuli are mathematically applied to the device under test.

## DEFINE WINDOW

Used to Modify (Filter) Frequency Domain Data Which Reduces Ringing & Overshoot in the Time Domain

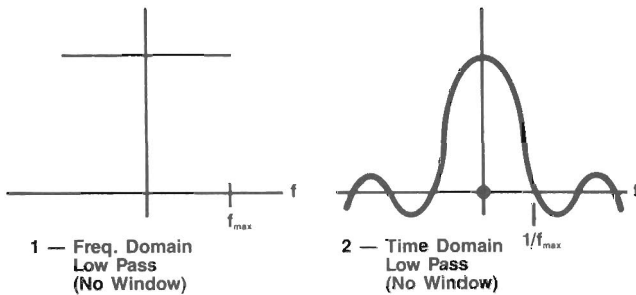

With no window, there is excessive ringing on the impulse in the time domain. Note that the width of the impulse at the zero crossings is  $1/F_{max}$ .

NO WINDOW =  
ABRUPT STOP IN FREQ DATA  
YIELDS RINGING IN TIME

2548

## DEFINE WINDOW CONT.

1 — Free Domain Low Pass (Windowed)

2 — Time Domain Low Pass (Windowed)

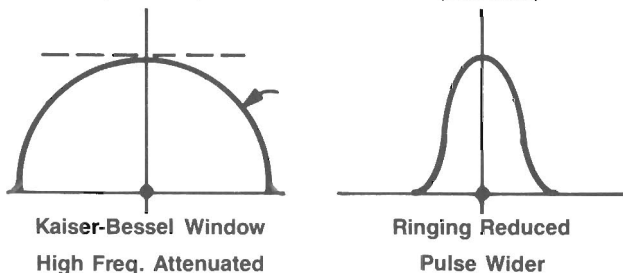

The window is applied to roll off the response at the frequency domain data discontinuities. The Kaiser Bessel Window is used in the 8510A. This high frequency attenuation reduces the ringing in the time domain but causes the impulse's width to increase. In the low pass mode, the window is centered at zero frequency and rolls off at plus and minus  $F_{max}$ .

2549

In the band pass mode, the window is centered between the start and stop frequencies. This windows both sides of the data and also reduces the effective bandwidth. This bandwidth reduction increases the impulse width.

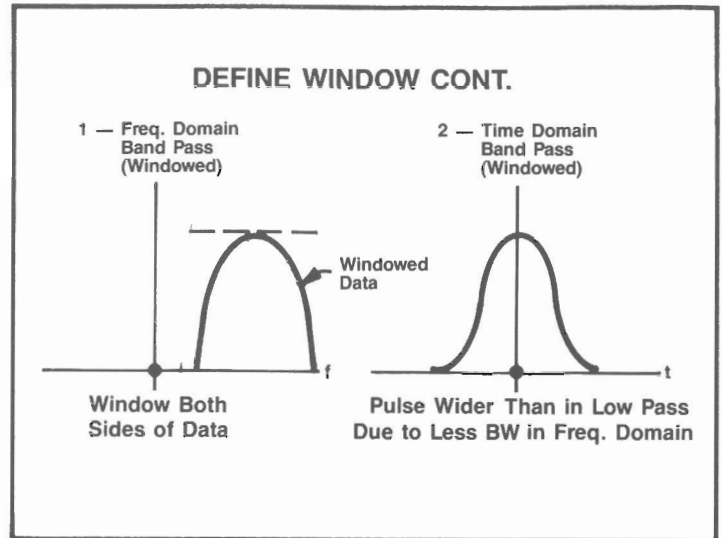

2550

The next three slides show the step response of a short circuit with different windows applied to the frequency domain data. With the minimum (no) window applied, we achieve the fastest rise time but with the most ringing.

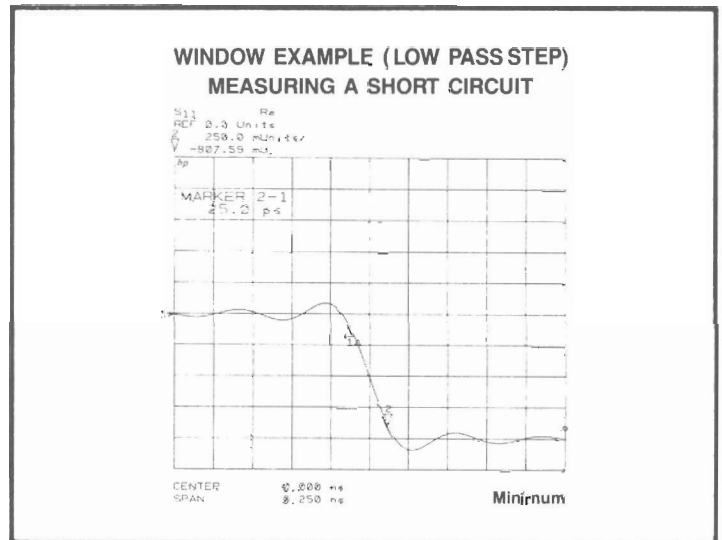

2551

The normal window greatly reduces the ringing but with a resultant slower rise time.

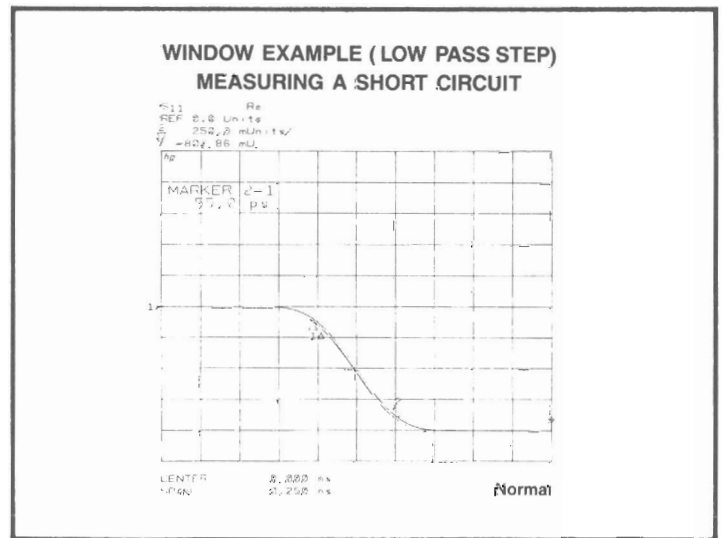

2552



**WINDOW EXAMPLE (LOW PASS STEP)  
MEASURING A SHORT CIRCUIT**

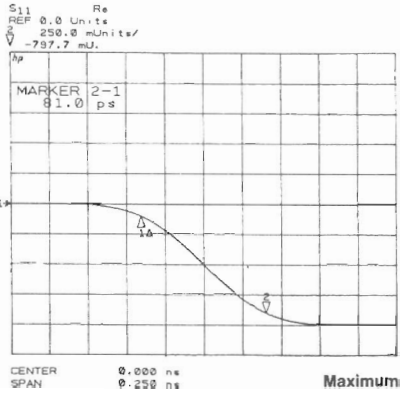

2553

The maximum window completely eliminates the ringing but at further degradation of the rise time.

**WINDOW SPECIFICATIONS  
(45 MHz - 18 GHz)**

		Rise Time 10%-90%	Pulse Width 50%	Side Lobe Level
Low Pass Step	Min.	25 ps	—	-21 dB
	Norm.	55 ps	—	-61 dB
	Max.	81 ps	—	>-90 dB
Low Pass Impulse	Min.	—	33 ps	-13 dB
	Norm.	—	54 ps	-44 dB
	Max.	—	77 ps	>-90 dB
Band Pass Impulse Lin. Mag.	Min.	—	66 ps	-13 dB
	Norm.	—	108 ps	-44 dB
	Max.	—	154 ps	>-90 dB

This table illustrates the tradeoff between rise time (or pulse width) and the side lobe level.

The rise time and impulse width apply only for the 18 GHz case and must be scaled for other frequency spans.

ILLUSTRATE TRADEOFFS WITH WINDOW VS SIDELOBE VS PULSE WIDTH  
 for 26.5 GHz → 6.6mm  
 26.5 GHz → SCALE BY 1 1/2

2554

**A THEORETICAL EXAMPLE CIRCUIT**

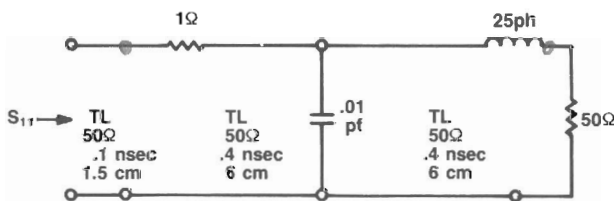

To illustrate the concepts discussed thus far, the following theoretical example is extremely helpful. We will examine the time domain response to different excitation and windows.

2555



**THEORETICAL EXAMPLE (LOW PASSSTEP)**  
 Frequency Max. Reduced to 12 GHz

S111A/R1 LIN MAG  
 SCALE/DIV: 0.00000  
 REF. VALUE: 00.

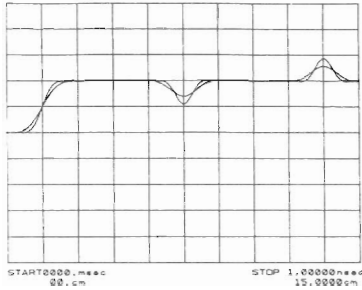

2559

If we decrease the frequency from 18 GHz to 12 GHz, the rise time increases. Note that the height of the resistor's response does not change but that the responses of the capacitor and inductor are a function of the frequency span.

*Is area constant?*

**THEORETICAL EXAMPLE (LOW PASSSTEP)**  
 Window Changed from Normal to Minimum

S111A/R1 LIN MAG  
 SCALE/DIV: 0.00000  
 REF. VALUE: 00.

ENTER  
 PLOT #

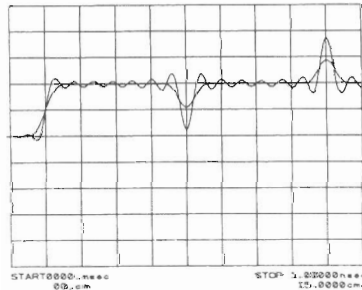

Note: Height of Reactive Elements Change

2560

As we change the window, the ripple level increases. Also notice that the height of the reactive elements increases.

**THEORETICAL EXAMPLE (BAND PASS IMPULSE)**

S211A/R1 L2% MAG  
 SCALE/DIV: 0.00000  
 REF. VALUE: 00.

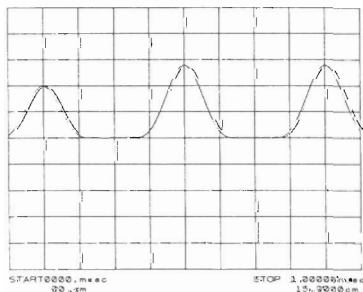

Linear Mag.

2561

In the band pass mode using the linear magnitude display format and impulse excitation, the location of the discontinuities is clear. The width of the impulses has increased because of the lower bandwidth, and the responses to the capacitive and inductive reactances have the same sign.

The log format is useful to display greater isolation between the circuit element responses.

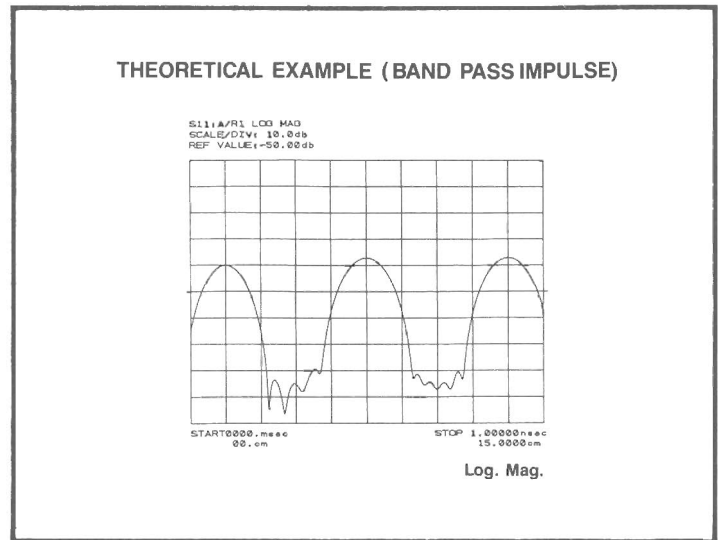

2562

### III. ADVANCED TIME DOMAIN

#### Topics in This Section

- Discrete Data Operations
- Chirp-Z Transform
- Gating
- Theoretical Gating Examples

2563

A. The next few slides will discuss the Discrete Fourier Transform. The frequency to time domain transform of continuous data is well understood.

B. However, the network analyzer gathers the data at discrete frequencies. This causes the data to be replicated in the time domain. This limits the range of the time domain to  $1/F$  where  $F$  is the frequency step size.

C. When we multiply the sampling function with our continuous frequency domain data, the resultant time domain response may have aliasing. This error is caused by the overlapping time domain responses.

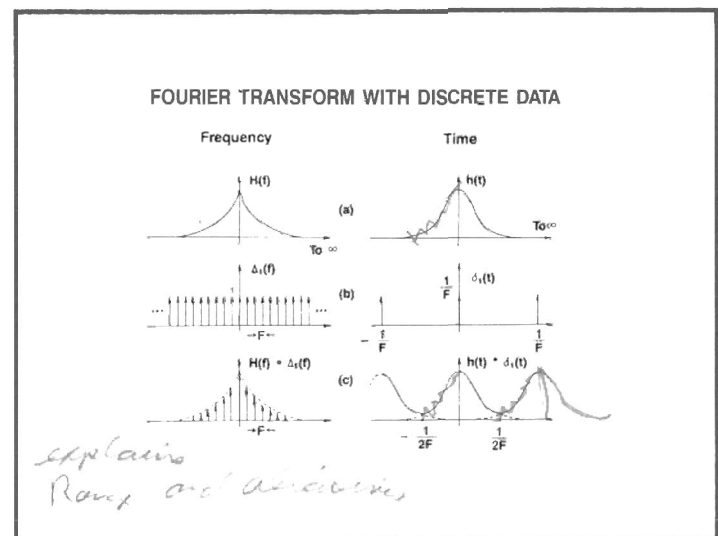

2564

CLOSE <sup>channel</sup> FREQ DATA  $\Rightarrow$  GREATER RANGE  
12

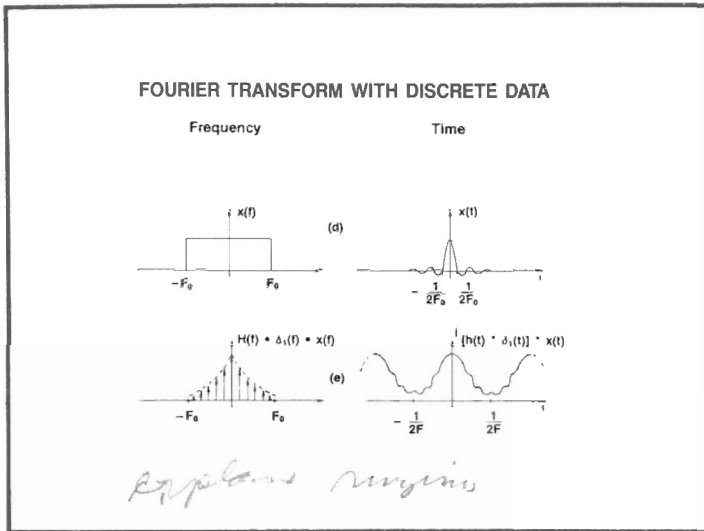

2565

D. The network analyzer also has limited frequency range so the data is truncated at some maximum frequency. This causes the replicating impulse to have a  $\text{SIN}(X)/X$  response.

E. This truncation function adds ringing to the time domain data. The ringing is exaggerated in this illustration.

*sinc/gc can be reduced by windowing*

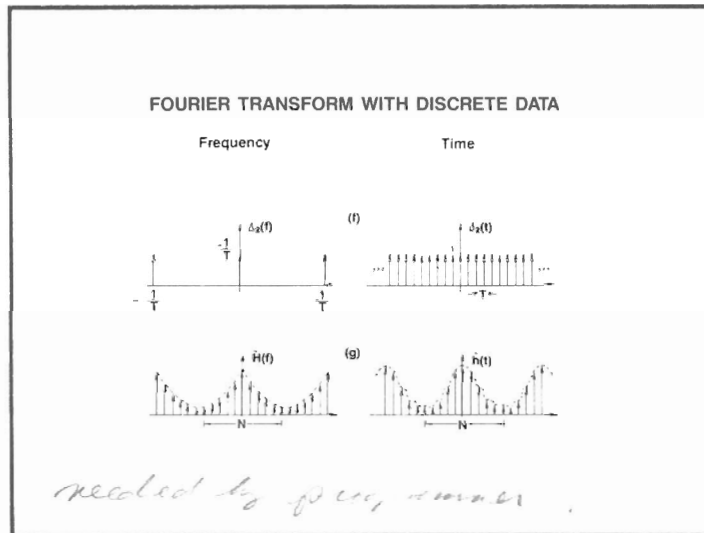

2566

F. Since a computer can only operate on discrete data, the time domain function must also be sampled. This requires the data in the frequency domain to be repetitive.

G. The final result of the Fourier Transform with discrete data can now be illustrated.

- INVERSE FOURIER TRANSFORM USING THE CHIRP-Z TRANSFORM**
- **Faster Than the Discrete Fourier Transform**
  - **Arbitrary Start & Stop Frequencies**
  - **Arbitrary Start & Stop Times**
  - **Arbitrary Number of Points in the Frequency Domain**
  - **Arbitrary Number of Points in the Time Domain**

2567

There are various techniques used to compute the inverse Fourier Transform. The most straightforward method is using the Fourier Series. The fast Fourier Transform has also been used. The Fourier Series method is very flexible and can achieve all the design goals except speed. The fast Fourier Series does not allow some of the flexibility desired. The Chirp-Z Transform is an algorithm that has the flexibility of the Fourier Series at about one half the speed of the fast Fourier techniques.

$$f(t) = \int_{-\infty}^{\infty} F(\omega) e^{j\omega t} d\omega$$

*-j\omega*  
*\sigma - j\omega*

The gating function is very useful for removing unwanted time domain responses. As long as the time domain responses are spaced far enough apart, the resultant frequency domain characteristics after gating can be very meaningful.

### DEFINE GATING

- The Gating Function Can Be Used to *Selectively Remove Reflection or Transmission Responses in Time. In Converting Back to the Frequency Domain, the Effects of the Gated-Out Responses are Removed.*
- The *Location of the Gate in Time Can Be Controlled by Setting the Center Position and Time Span or the Start & Stop Position of the Gate.*
- Gate Shape Controls the *Flatness, Rolloff Rate & Side Lobe Level of the Gate.*

2568

A gate is nothing but a filter in the time domain. The filter's pass band can be selected by the start and stop gate controls. The filter has a pass band ripple, a cutoff rate, and side lobe level just like its duals in the frequency domain. The unwanted time domain responses will be reduced by this filter but not totally removed. Even the most simple impulse response is not localized in time, but is spread out and has side lobe ripples that may not be easily removed by filtering.

*IF filter analogy in FM Receiver*

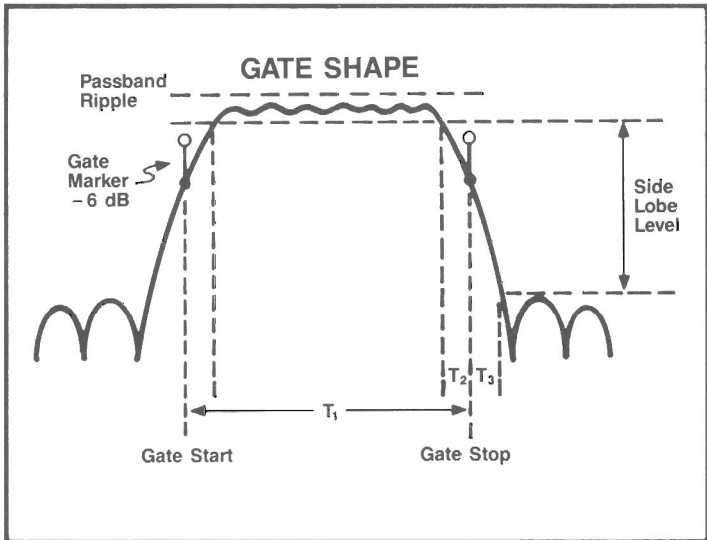

2569

The following four slides show the filter shape of the available gates in the 8510A Network Analyzer. The minimum gate shape has the highest passband ripple and side lobe level but has the fastest cutoff rate for separating closely spaced time domain responses. This fast cutoff rate does not come without problems. The data in the frequency domain will have some ripple at the frequency band edges when the gating function is turned on.

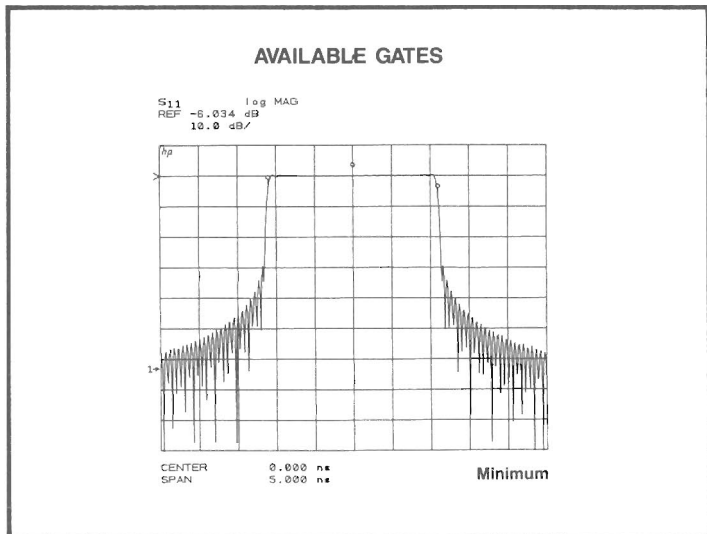

2570

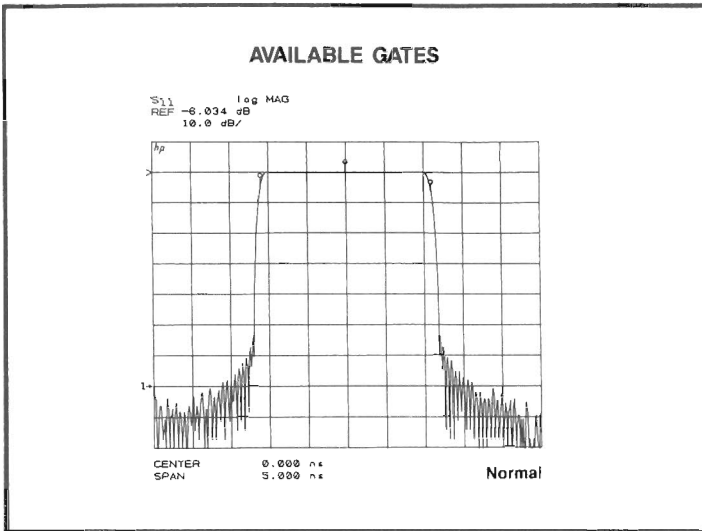

2571

This is the normal gate shape. It is a good compromise for most applications. It has relatively low side lobes and passband ripple combined with fairly fast cutoff rate. All the gates are synthesized by convolving a time domain rectangle function, whose span is determined by the gate controls, with an impulse response windowed with a Kaiser-Bessel function.

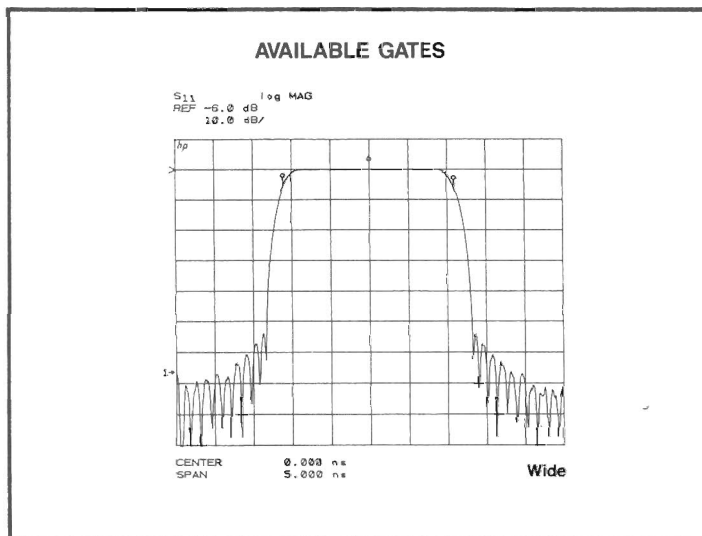

2572

If the time domain responses are separated by 10 to 15 cm, this is a good filter that reduces gating errors in the frequency domain.

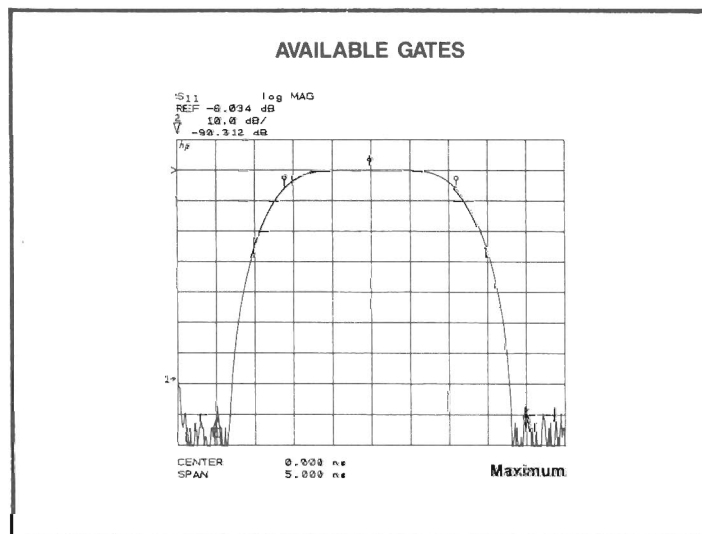

2573

For responses separated by 20 to 30 cm, this is an excellent filter with virtually no passband ripple and extremely low side lobes. The cutoff rate is not fast, but the errors in the frequency domain are limited to just the frequencies close to the band edges.

This table summarizes the available gate shapes for the 8510A Network Analyzer. If the gate span is chosen less than the minimum  $T_1$ , the actual width of the gate will not decrease, and there will not be a flat passband region. This table applies only for the 18 GHz case and must be scaled for other frequency spans.

SLIDE WRONG

**GATE SHAPES**  
(45 MHz to 18 GHz Case)

Gate Shape	Passband Ripple (Peak to Peak)	Side Lobe Level	$T_2, T_3$ & Min. $T_1/2$
Maximum	.01 dB	80 dB	620 psec
Wide	.02 dB	52 dB	220 psec
Normal	.04 dB	45 dB	90 psec
Minimum	.4 dB	24 dB	33psec

2574

The start and stop gate markers are located at the -6 dB points of the time domain filter.

REVIEW GATE CONCEPT

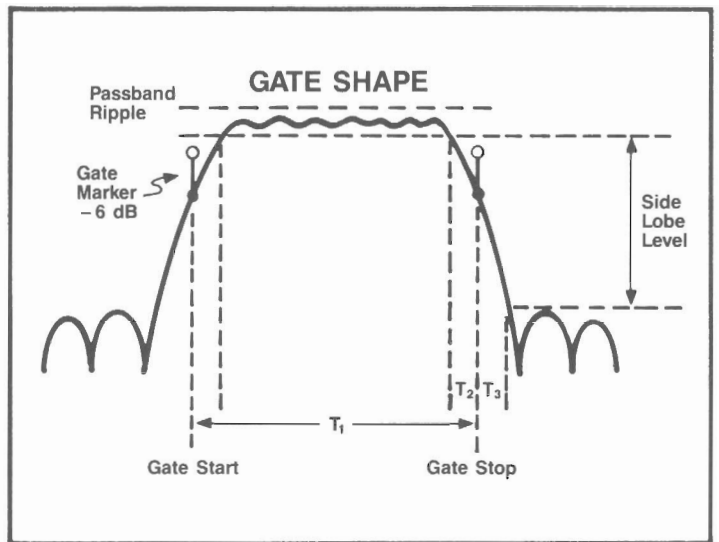

2569

We will use the same example circuit to illustrate the effects of gating.

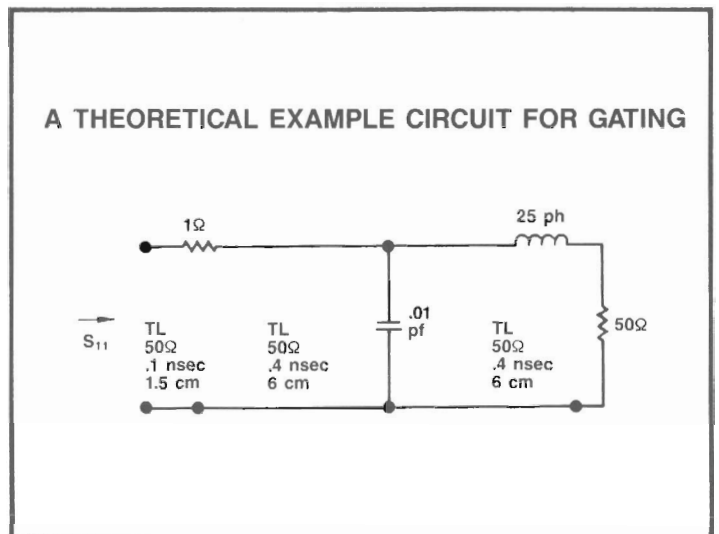

2575



### THEORETICAL EXAMPLE AND GATING

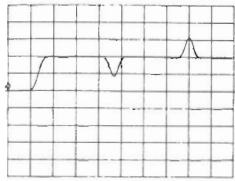

Time Domain

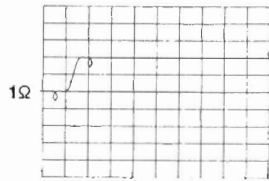

Time Gated (1Ω)

Again we see the low pass mode step response. If we center the gate around the series resistor we remove the responses of the capacitor and inductor. It is important that the gate be centered on the response we wish to keep, or additional errors can result.

2576

### THEORETICAL EXAMPLE AND GATING

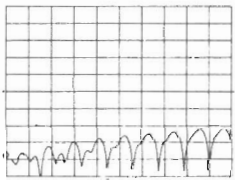

Frequency Domain

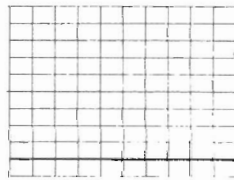

Freq. Gated (1Ω)

After gating, the frequency domain characteristic of the one ohm resistor is a flat response 40 dB down.

2577

### THEORETICAL EXAMPLE AND GATING

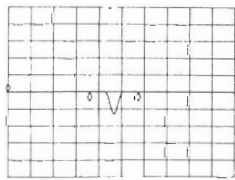

Time Gated (.01 pf)

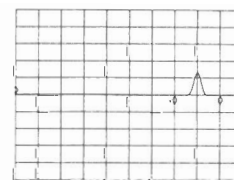

Time Gated (20 pH)

When we gate around the capacitor and inductor, notice that the base line is restored and the shift caused by the one ohm resistor is removed. The result is that the responses in the gate area are shifted to the reference line which becomes the new impedance standard. The frequency domain results for the inductor and capacitor are very similar since the reactances are nearly the same size. The phase is -90 deg for the capacitor and +90 deg for the inductor.

2578

When we gate around the capacitor and inductor, notice that the base line is restored and the shift caused by the one ohm resistor is removed. The result is that the responses in the gate area are shifted to the reference line which becomes the new impedance standard. The frequency domain results for the inductor and capacitor are very similar since the reactances are nearly the same size. The phase is  $-90$  deg for the capacitor and  $+90$  deg for the inductor.

*NOTE  $+90^\circ$  &  $-90^\circ$*

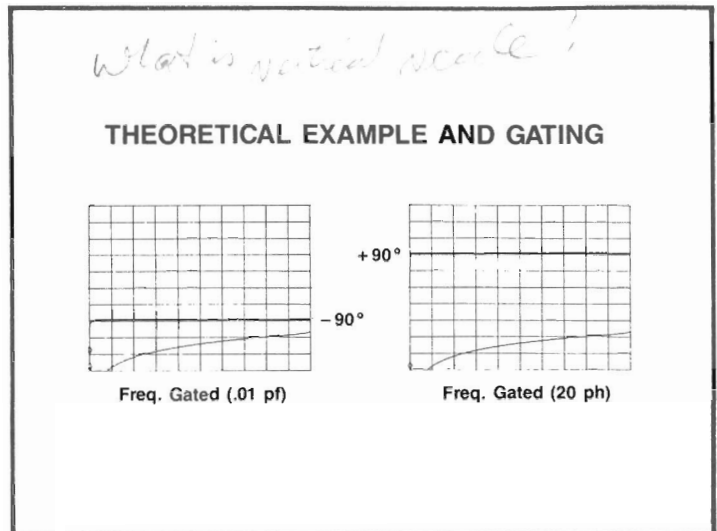

2579

This section contains a series of examples to further illustrate the capabilities of time domain, and to help cement the concepts discussed in the earlier sections.

## IV. APPLICATION EXAMPLES

### Topics in This Section

- $50\Omega$  to  $25\Omega$  Airline Transitions
- $50\Omega$  Airline with Various Terminations
- Slotted Line Capacitive Probe
- 8514A Test Set
- 7 mm to 3.5 mm Adapter
- Fault Location
- Antenna Example
- Potential Problems

2580

The first example is a 25 ohm airline, 7.5 cm long. There are two transitions, one from 50 to 25 ohms and then a second transition back to 50 ohms.

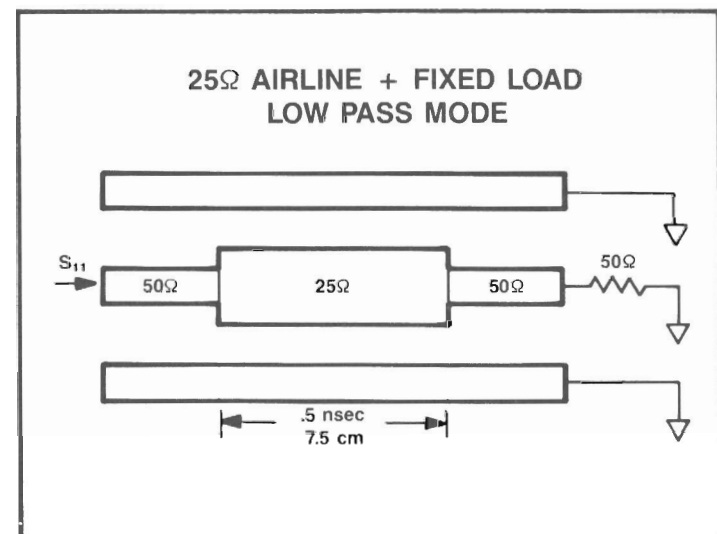

2581

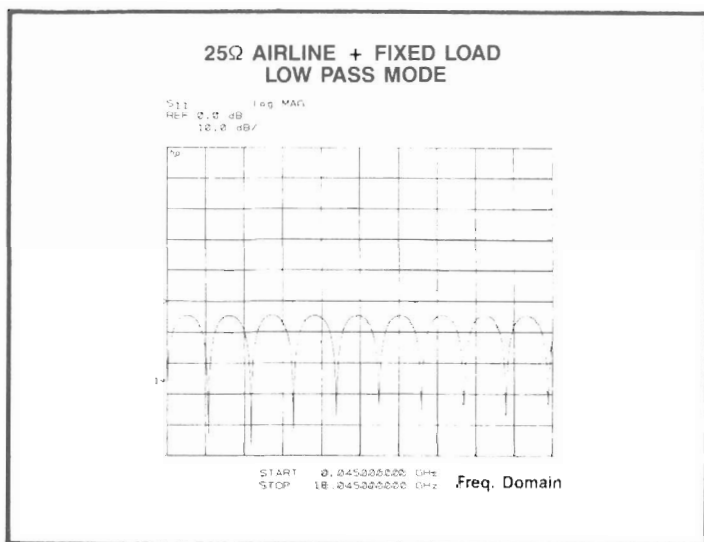

The frequency domain shows a beat pattern caused by the mismatches at the two transitions. The nulls occur at frequencies where the effects of the transitions cancel. These frequencies are not equally spaced because of the fringing capacitance at the step discontinuities.

2582

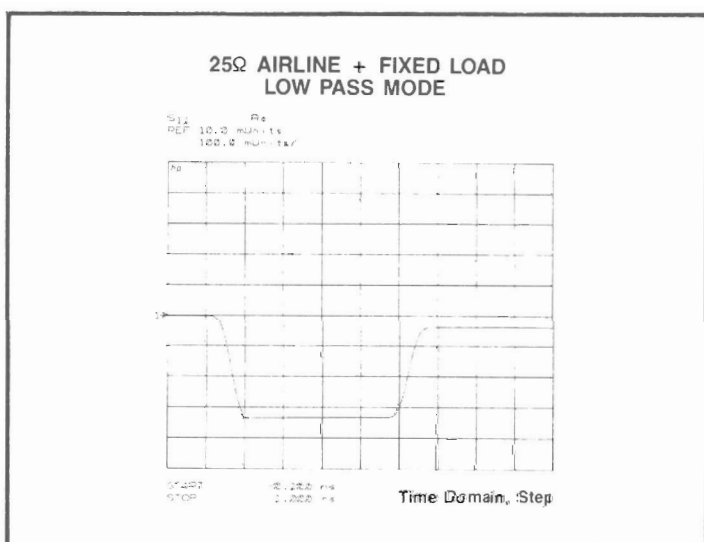

In the low pass mode with step excitation, the step drops down to the 25 ohm level but does not return back to the 50 ohm level at the second step. This effect is called masking. Part of the energy is reflected from the first step and never reaches the second step. It is important to remember that prior reflections can change the level and shape of the step that is presented to the following circuit elements. If the earlier reflections are of low enough level, the masking is usually insignificant.

EXPLAIN MASKING

2583



Expanding the step response in the 25 ohm section shows a slope upward due to the series loss of the airline. The ripple is caused by the window function not completely removing the ringing in this expanded view.

SERIES LOSS

2584

With impulse excitation the response first goes down and then at the second step responds upward. The height of the impulses is the same as the step sizes of the previous slide.

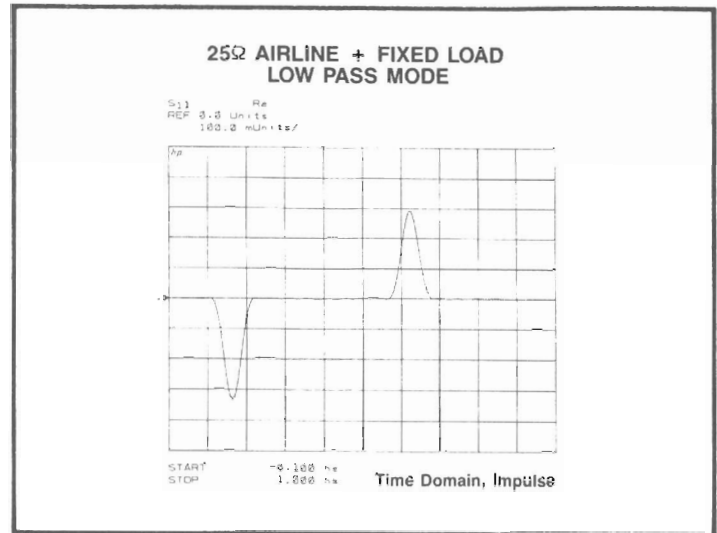

Band pass mode with impulse excitation and the log format allows us to have a high dynamic range view of the 25 ohm airline. A gate is centered around the first step and the second transition is filtered or gated out.

*What are the two traces?  
one gated, one ungated*

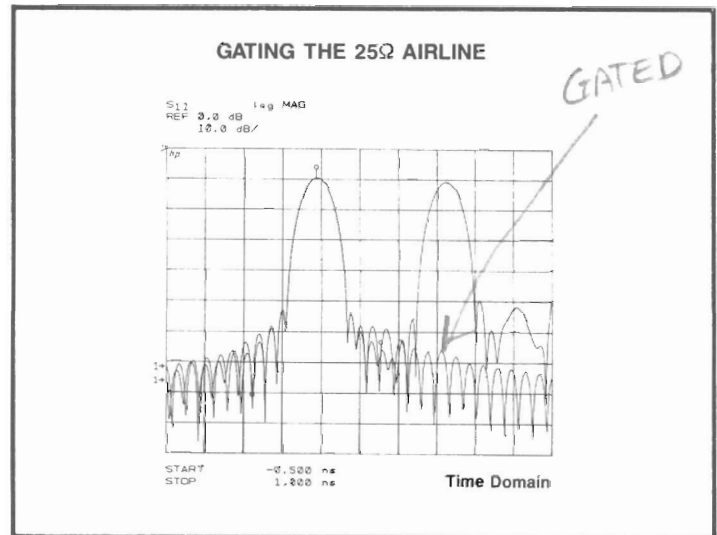

The gated frequency domain characteristic has no beat pattern, just the flat response of a single 50 to 25 ohm transition.

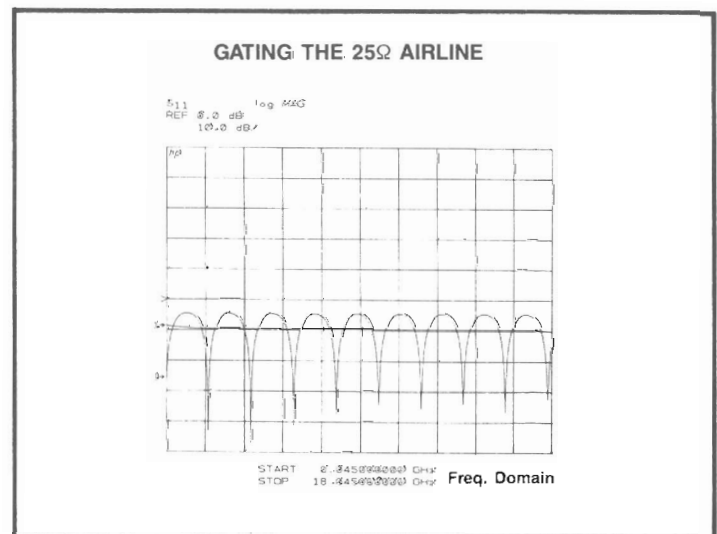

# ERRORS DUE TO SIDE LOBES NOT GATED OUT

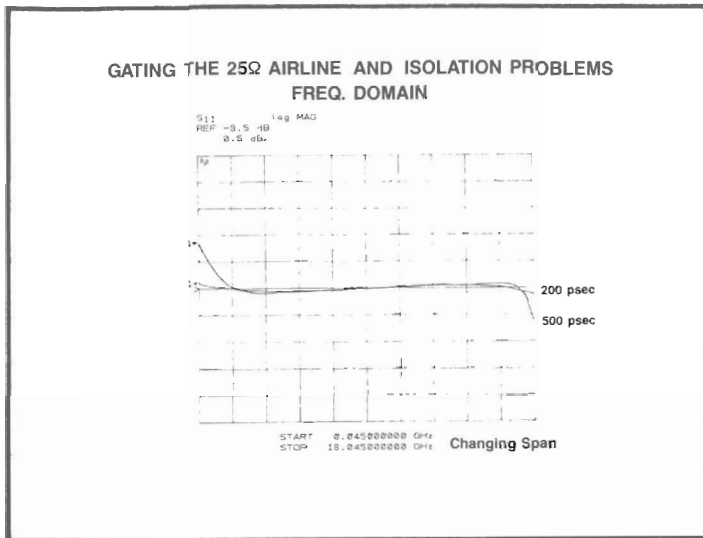

2588

Looking in detail at the frequency domain shows band edge errors caused by the gating function. This distortion is caused by the side lobe level of the second transition that remained in the gate area centered around the first step. Note that if the gate span is reduced, less of this side lobe level remains and the distortion is reduced. In summary, this error is due to imperfect isolation between responses in the time domain caused by the side lobe energy.

*Review*

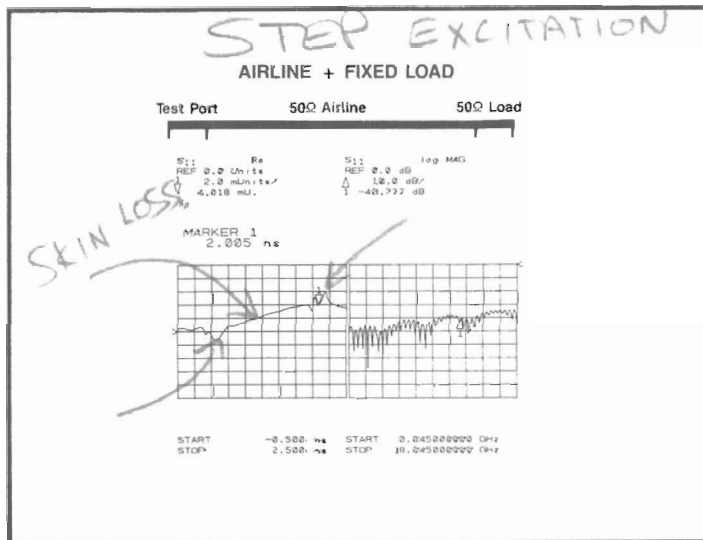

2589

This example is a 50 ohm airline terminated by an imperfect 50 ohm load. We are using the low pass mode with step excitation. It is easy to identify the transition from the test port to the 50 ohm section. The upward slope in the airline section is due to series resistance primarily caused by the skin loss. The transition to the load and response of the load element is clearly separated.

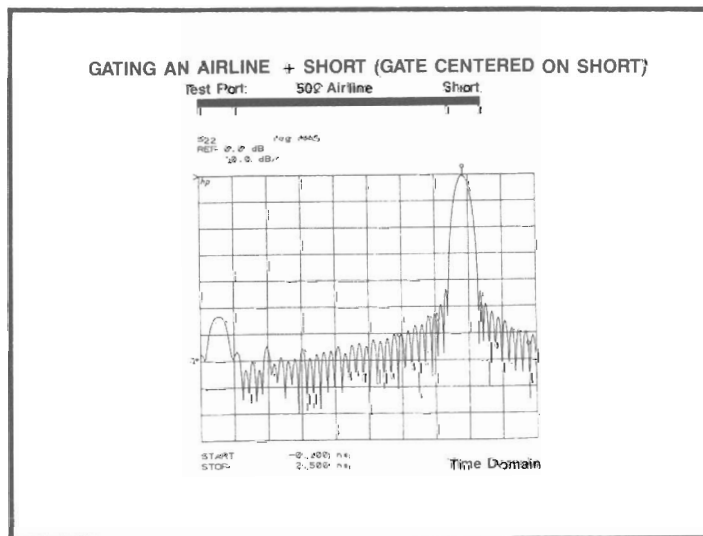

2590

In this example the 50 ohm load is replaced by a short. Viewing the response with the log format in the band pass mode shows the high dynamic range possible. The side lobe pattern is also clearly visible. The side lobe level could be reduced by using the maximum window. The residual reflection at the transition from the test port to the airline is about 55 dB down.

Gating around the short removed the effect of the transition to the airline. Again, it is important to center the gate about the reflection of the short.

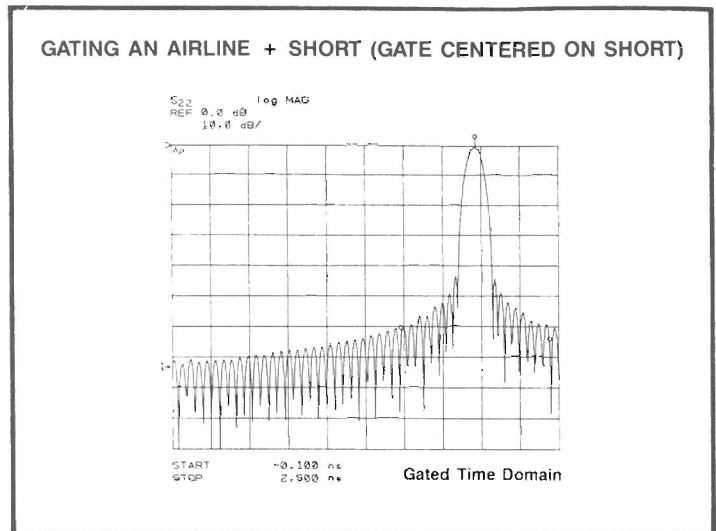

2591

In the frequency domain, the gating function removed the residual frequency response ripple caused by imperfections at the test port connector.

*2-traces:  
with &  
without gating*

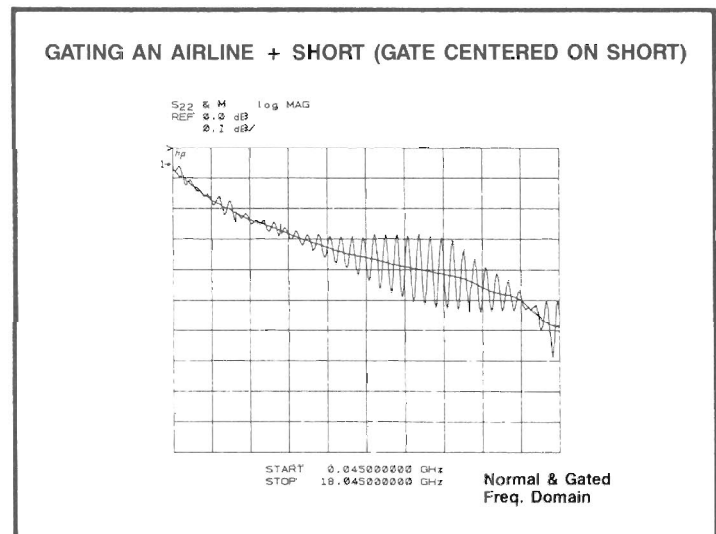

2592

Next a 40 dB pad is inserted before the airline and the short. The reflection of the short is now 80 dB down and clearly identifiable.

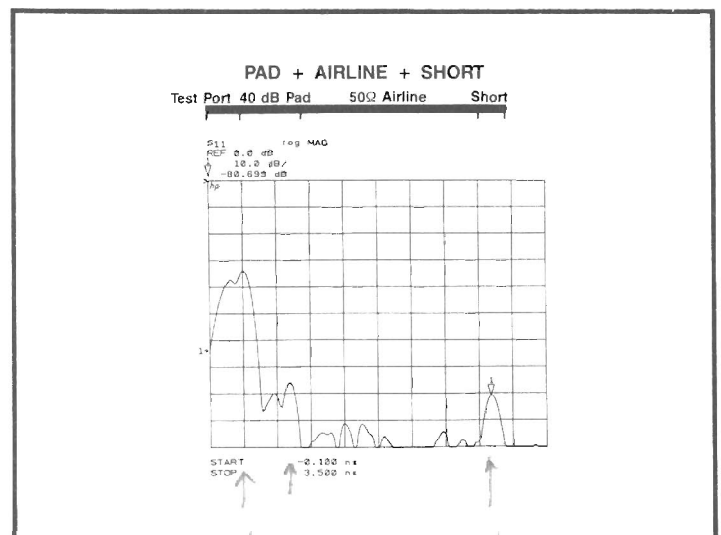

2593

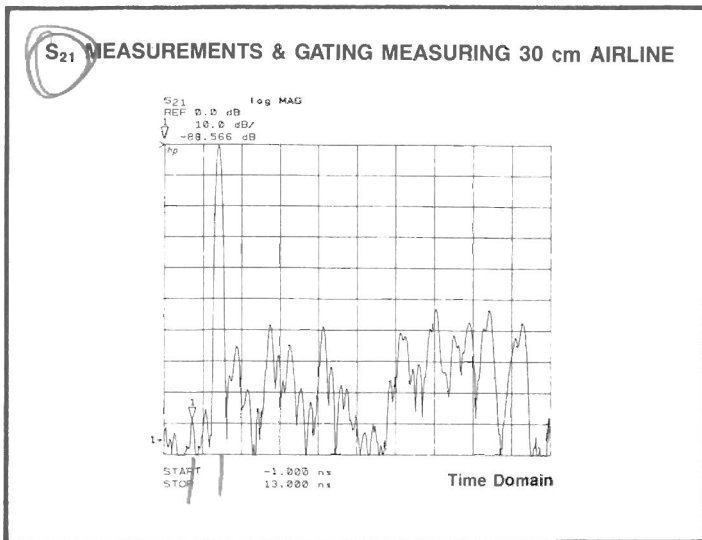

Using the same airline we will now measure the transmission coefficient. Again we are using the band pass mode with the log display. The impulse first arrives followed by a host of multiple reflections caused by imperfect port matches of the non error corrected network analyzer. The frequency domain response has been normalized to remove the transmission tracking error.

2594

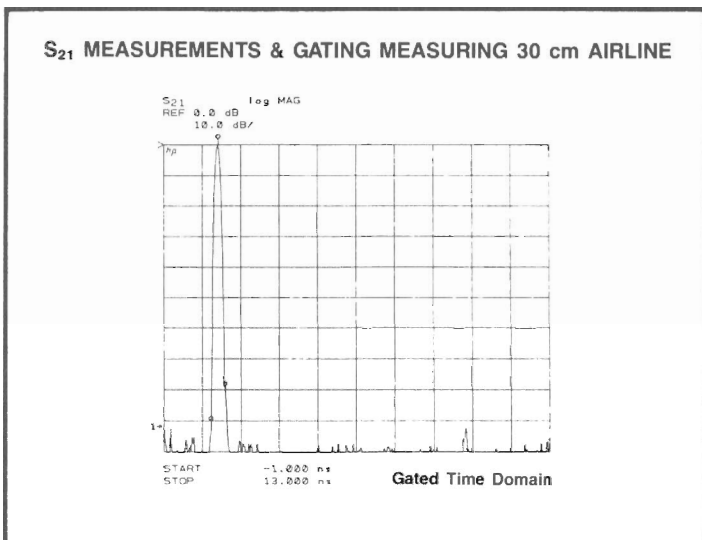

Gating easily removes the multiple re-reflections.

2595

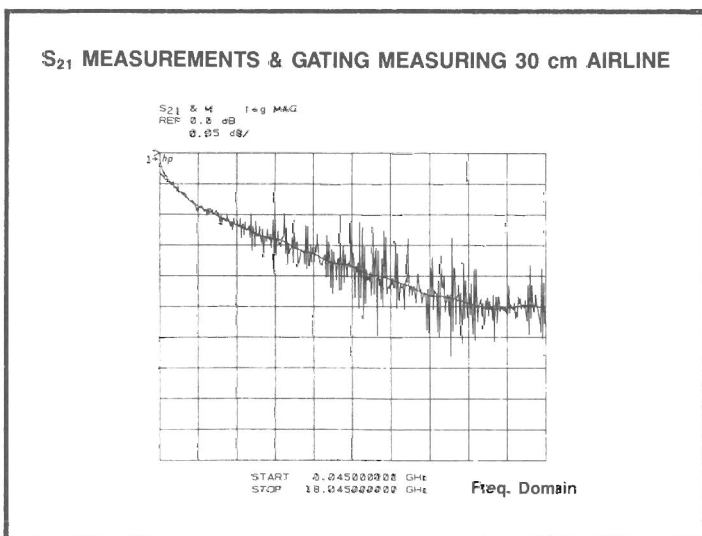

Removing the reflections in the time domain filters the frequency domain ripples. The ripples would have been much smaller if complete error correction had been used. Then the gating would clean up the last residual errors and excellent characterization of the airline skin loss would result.

2596

The next example uses a slotted line with an adjustable probe.

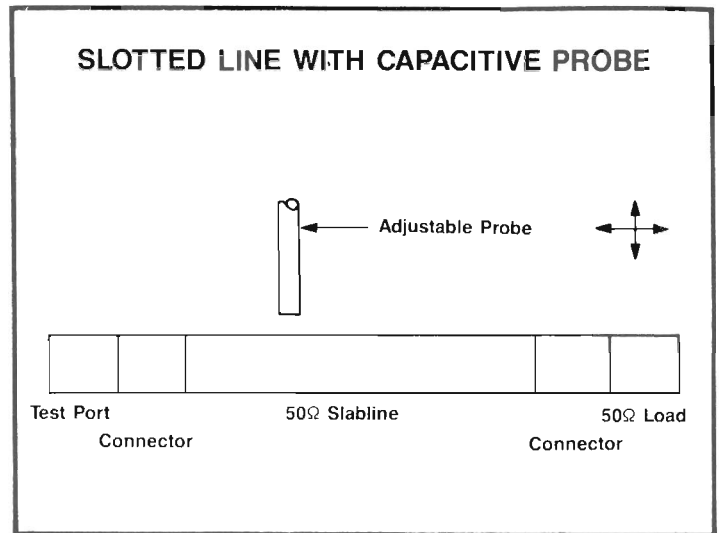

2597

We are now using the low pass mode with step excitation. The two transitions into and out of the slab line section are small but still clearly visible. The larger downward response is caused by the capacitance of the probe. Gating easily removes the slab line launch problems. It is important to notice that the time domain response at the first gate marker is restored to the reference line and the new reference impedance is that of the slab line.

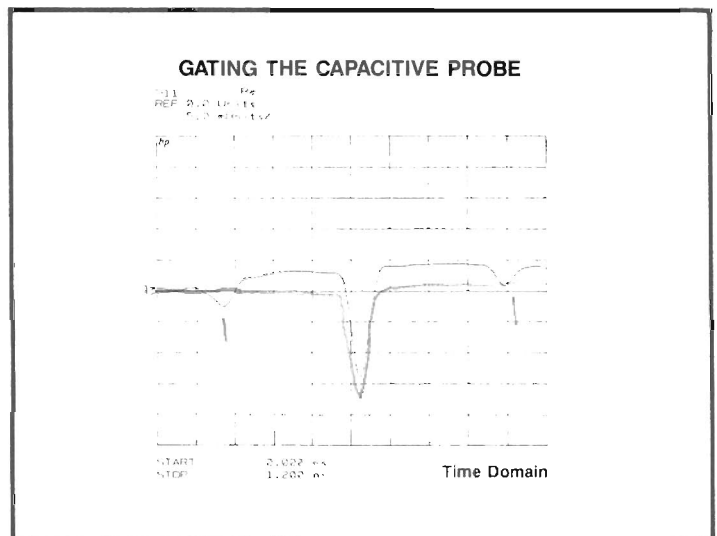

2598

In the frequency domain the filtered response is excellent. The capacitive response is clearly identified. Note that the response is starting to reduce at the high frequency end. Actually the probe has a finite length and is a low impedance section of line and not a single point discontinuity.

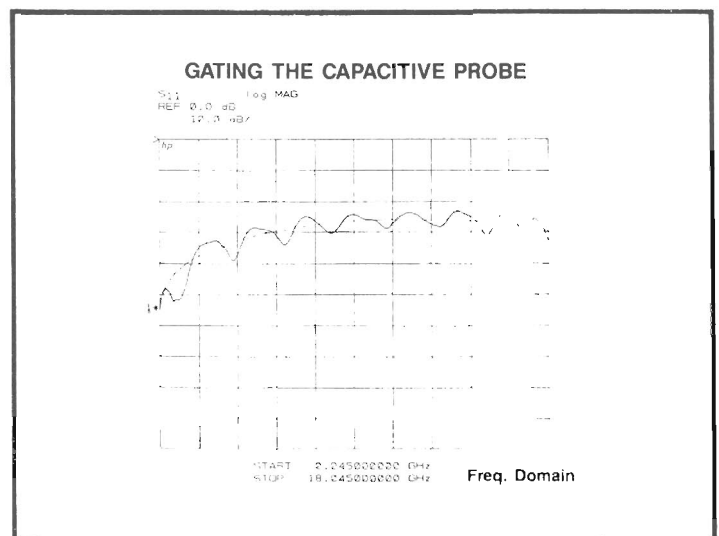

2599



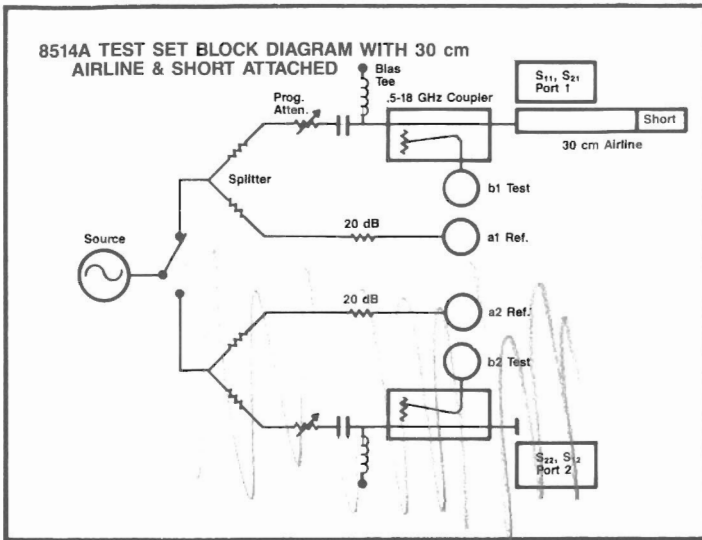

2600

In this example, a 30 cm airline terminated with a short is connected to Port 1 of the 8514A S-parameter Test Set. The error correction is turned off, and the bandpass mode is used. The time domain impulse travels through the test set, leaves Port 1, and is reflected back into the test set from the short at the end of the airline.

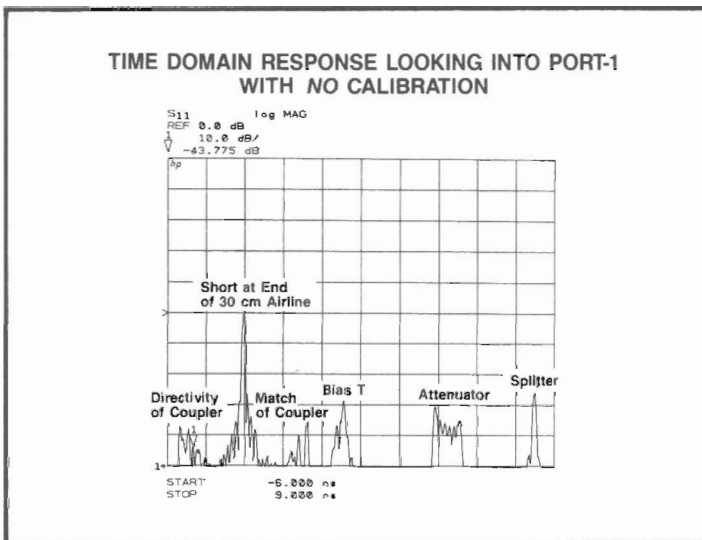

2601

The various errors of the test set can be identified. Even the input and output reflections and the four attenuator cards of the step attenuator are visible.

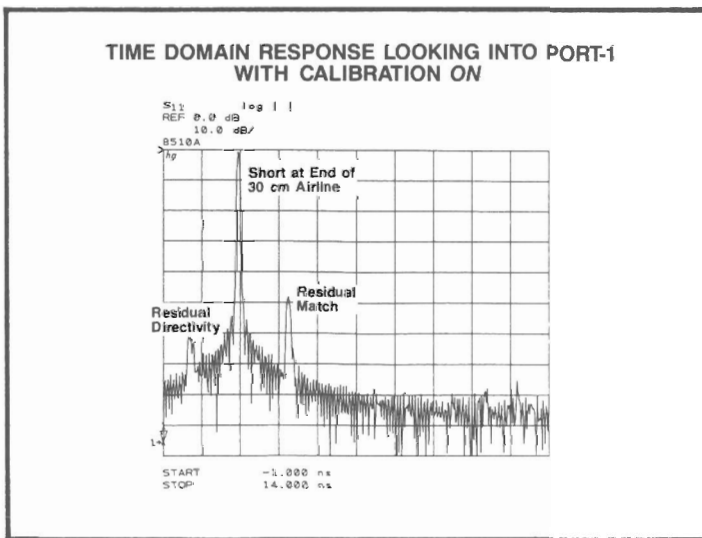

2602

When error correction is turned on, all the errors are removed except the residual directivity and source match. Notice that the residual directivity is over 60 dB down, and the residual source match is almost 50 dB down. The other fine-grain ripple is caused by the normal window.

Time domain is helpful in measuring adapters between different connector types or impedances. All that is needed is a good airline and load for Port 2 of the adapter. Then a gate can be centered around the adapter and the effect of the load at the end of the airline is removed. The adapter is then terminated with an effective load the quality of the airline.

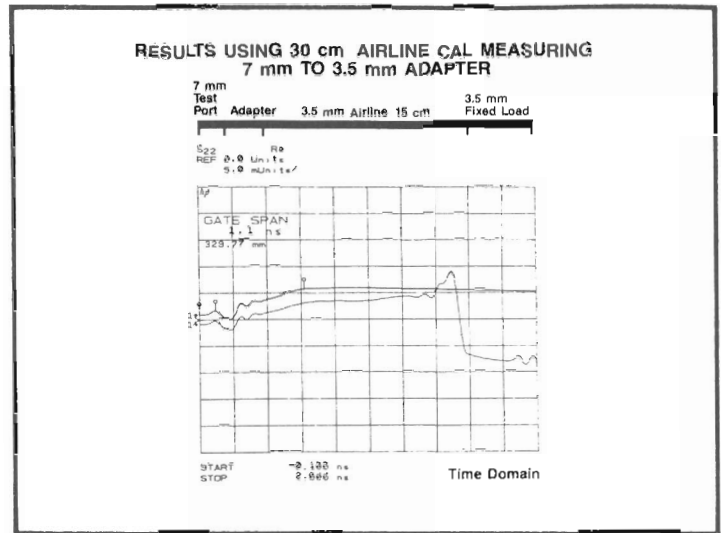

2603

The result in the frequency domain is dramatic. A 10 to 20 dB improvement of the reflection coefficient is realized. This approach can also be used to obtain the transmission coefficient of the adapter.

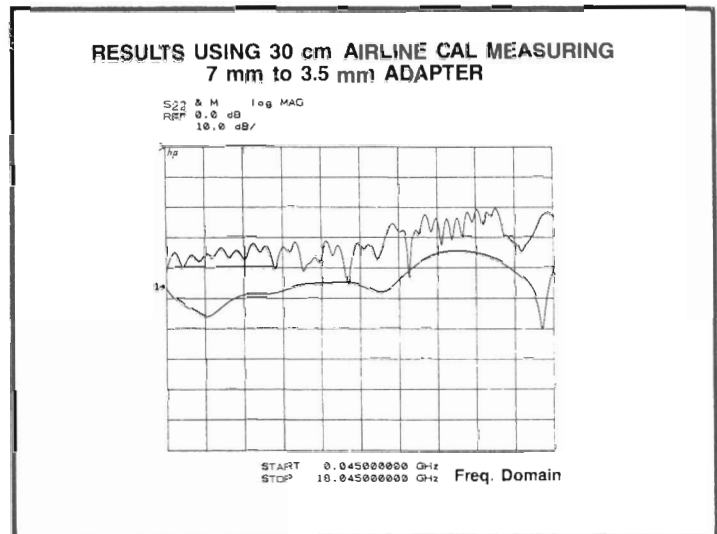

2604

Fault location is a powerful application of the bandpass mode. Let's take a simple example of a coaxial cable with two connectors on it and two bends in it.

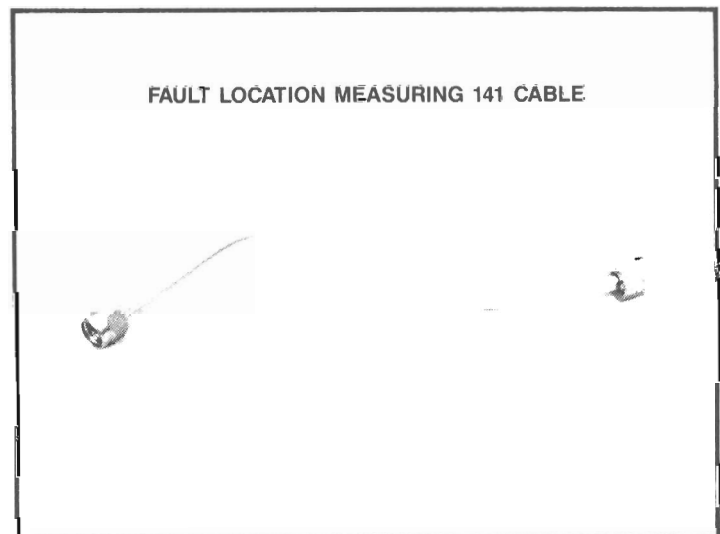

2661

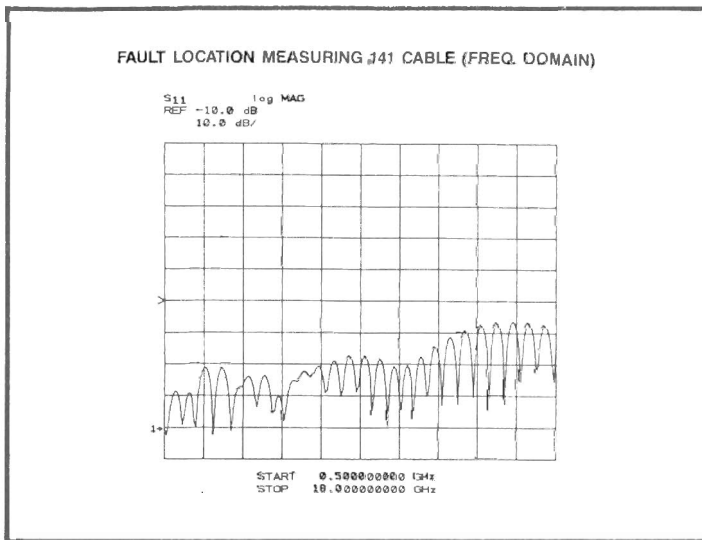

2662

Here is the composite frequency domain response of the input reflection coefficient of the cable shown above. Notice that it is impossible to tell where the major reflections are within the cable. What we are seeing is all the reflections in the cable added up together at each frequency point to give us the composite response.

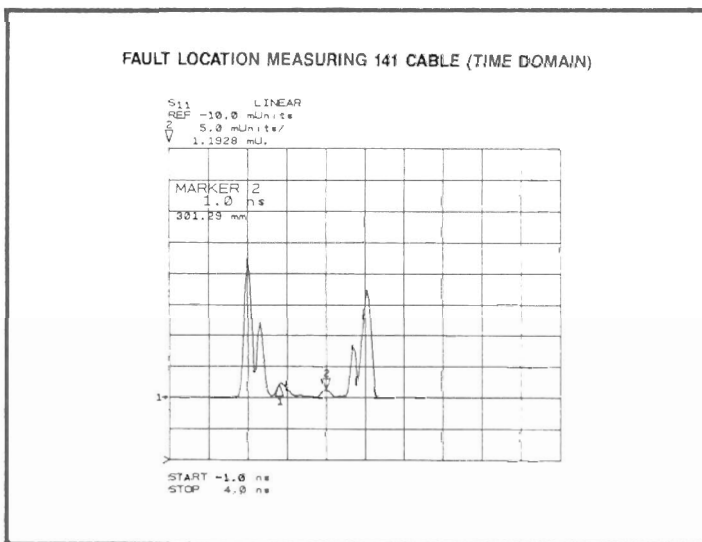

2663

Now look at the time domain response to the reflection measurement. We can see not only the two larger connector responses but also the individual responses due to the two bends in the cable.

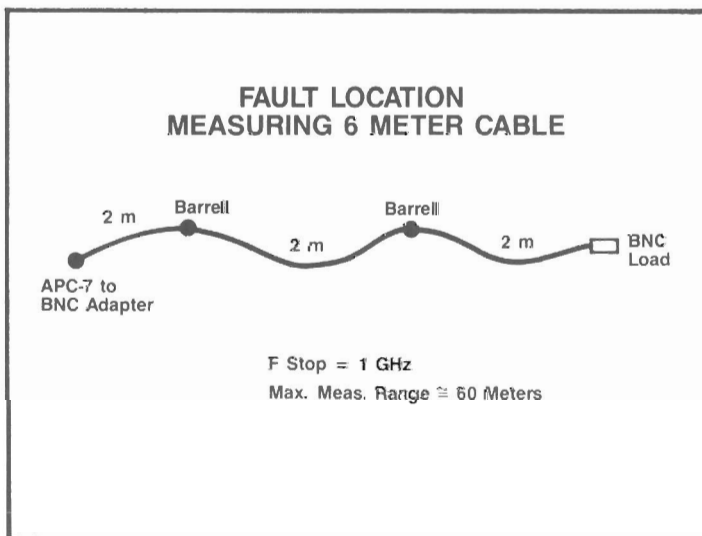

2607

In this example, we take three BNC cables connected with adapters and terminated in a 50 ohm BNC load. In order to increase the measurement range (in distance), the stop frequency is reduced to 1 GHz.

First we see the frequency domain response.

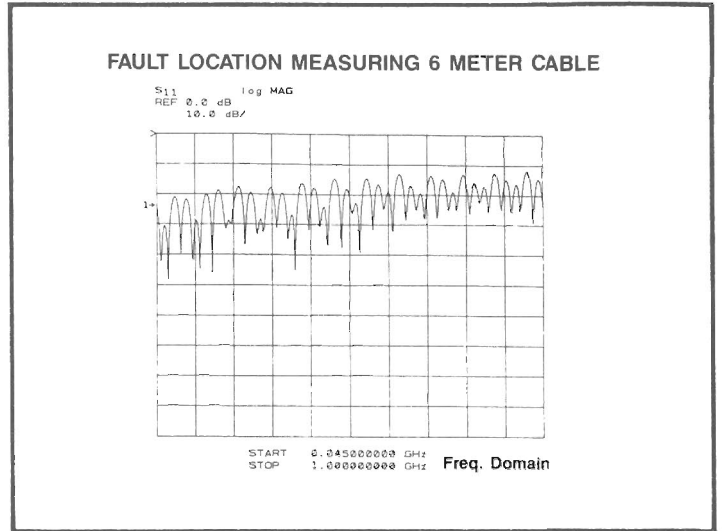

2608

The time domain response clearly locates the adapters and terminating load.

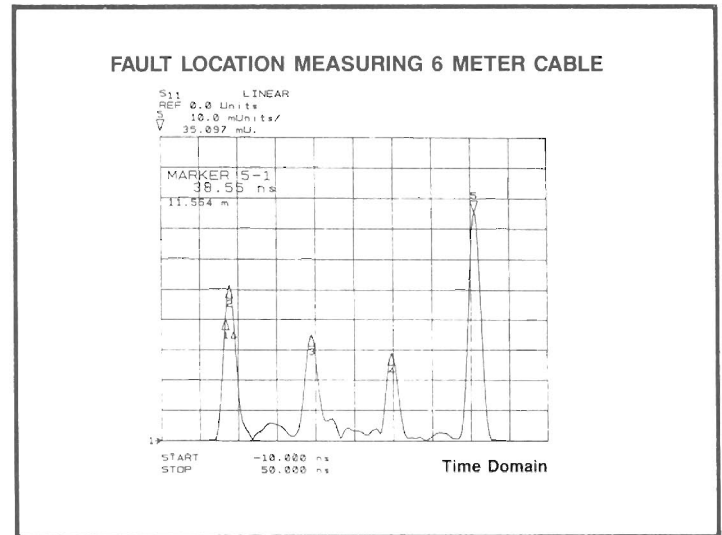

2609

As an example of fault location with high resolution, we tested a 200-foot piece of cable in the reflection mode terminated by an open circuit. After finding the open circuit response in the time domain (200 feet away from the test port), we attached a 1.5 inch barrel at a small incremental distance from our original open circuit measurement. We also would suspect that the response would be slightly smaller due to the additional loss caused by the extra length of the barrel.

The responses shown here are from both the 200-foot piece of cable and the cable with the barrel attached. The response with the barrel is offset in time from our original response by approximately 200 ps and its amplitude is smaller by approximately .0005 in reflection coefficient.

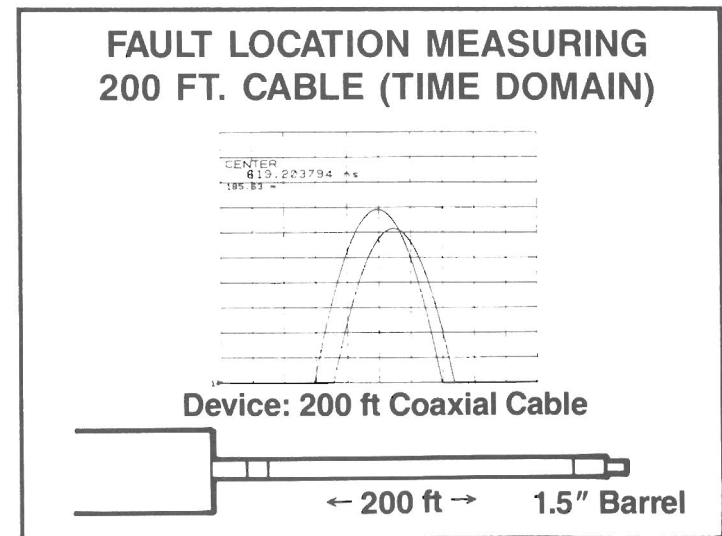

2665



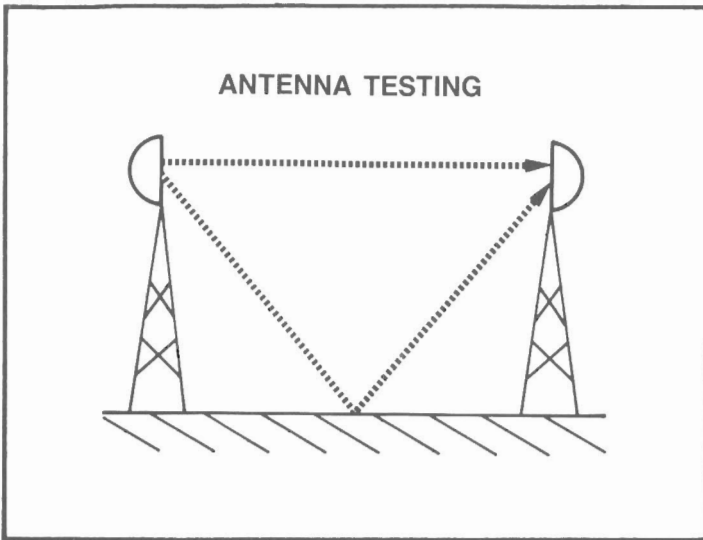

2666

In antenna testing, large sums of money are expended to absorb unwanted reflections both on outdoor ranges and anechoic chambers. In this example, the desired path is normally the most direct one (the fastest time). But there is also ground clutter path which arrives at the receiving antenna slightly later.

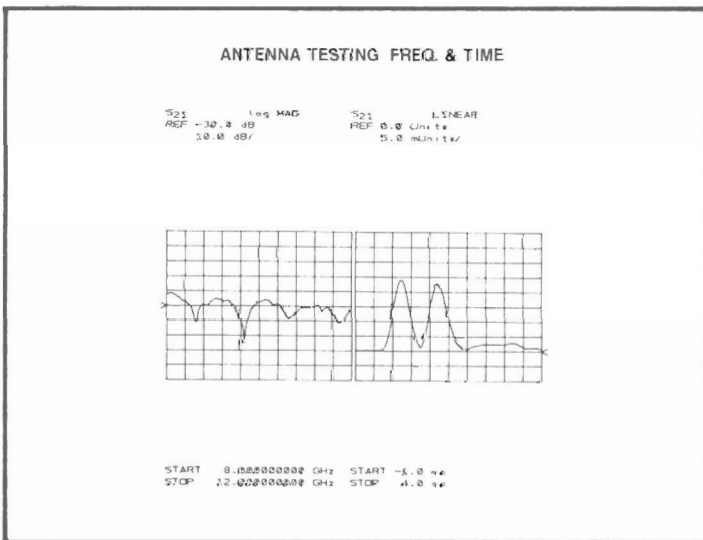

2667

We can see both the frequency and time domain responses of the antenna pair. The first impulse is the direct path; the second is due to the ground path. This ground path causes the frequency domain data to be very rough.

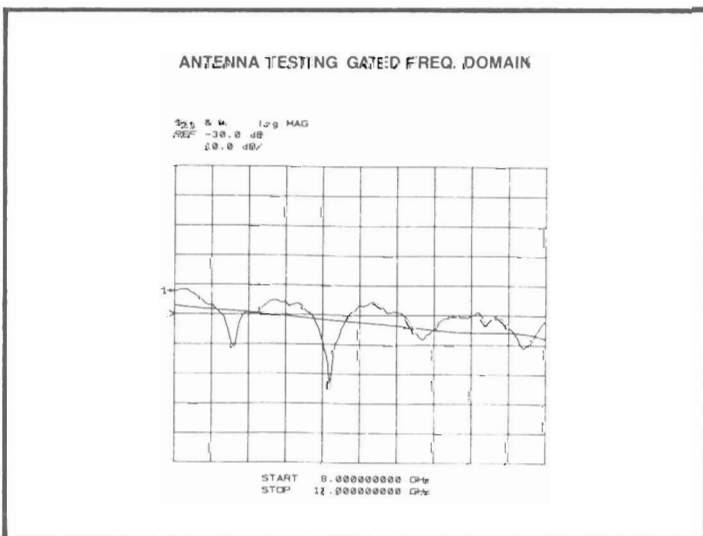

2668

Now with the gate on, the new time domain data is transformed back to the frequency domain which now shows just the frequency response of the direct path. This gated data is compared with the ungated data previously stored in memory. Note the interference in the memory trace caused by the reflections from the second longer path. Gating has effectively eliminated this interfering signal.

The last six slides discuss some of the system limitations when using directional coupler-based test sets and non-synthesized sources. First let us consider the effect of the coupler rolloff below .5 GHz. In the non-error-corrected case, the response looks like a high-pass filter,

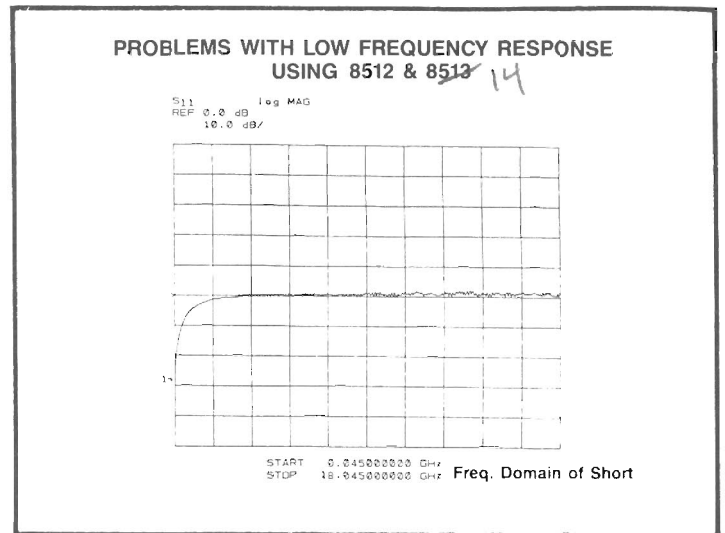

2611

This frequency domain response causes the time domain step to be differentiated. Now when we error correct, this problem is eliminated, but the signal-to-noise ratio of the first few harmonics is reduced. When measuring small reflections, lower signal-to-noise ratio causes the time domain trace to bounce up and down. Averaging reduces this problem, but then we may lose the real-time adjustment capability.

*Review*

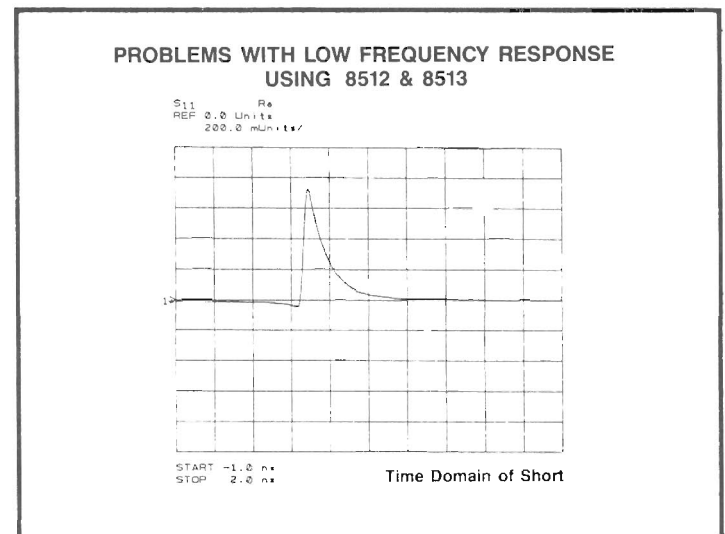

2612

Next we look at the deviation from linear phase of a 30 cm airline. When the 8340A Synthesized Sweeper is in ramp mode, this slide shows the phase discontinuities at the frequencies where the source changes bands.

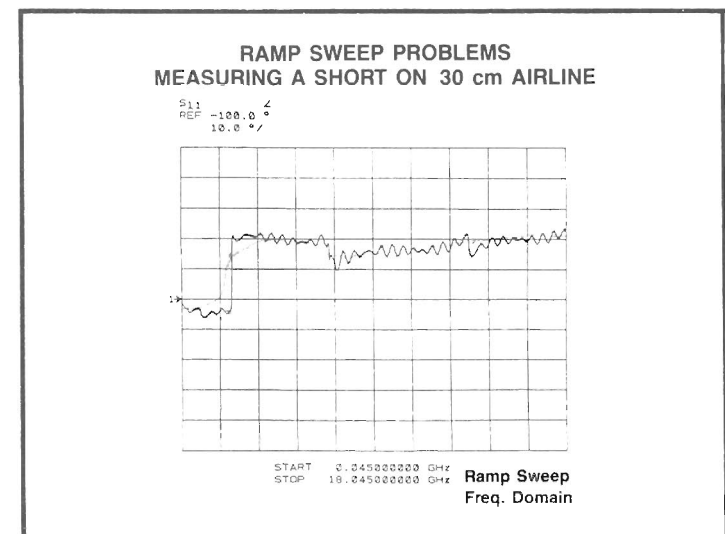
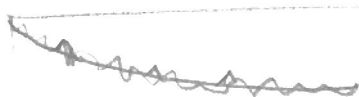

2613

**RAMP SWEEP PROBLEMS  
MEASURING A SHORT ON 30 cm AIRLINE**

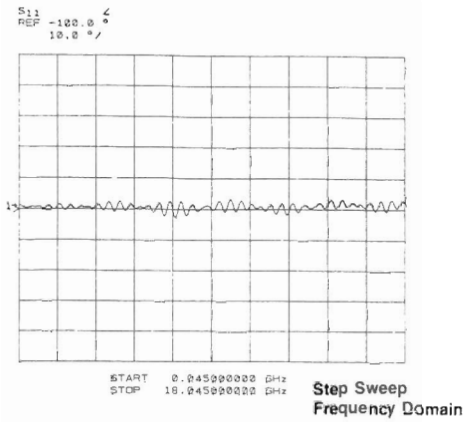

2614

When in synthesized step mode, the phase discontinuities are removed.

**RAMP SWEEP PROBLEMS  
MEASURING A SHORT ON 30 cm AIRLINE**

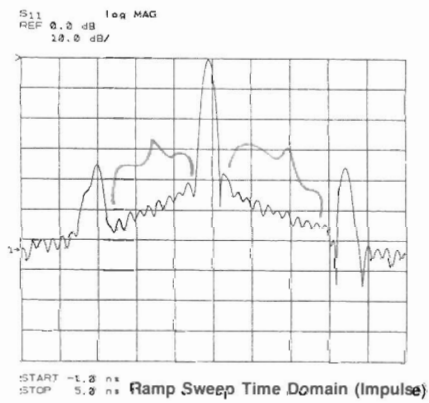

2615

The resultant time domain, when the source is in ramp mode, has additional side bands caused by the phase discontinuities. This may or may not cause problems depending on the application.

**RAMP SWEEP PROBLEMS  
MEASURING A SHORT ON 30 cm AIRLINE**

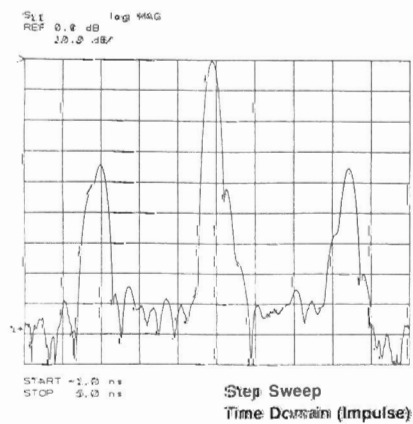

2616

In step mode, the side bands are gone, and we have regained our full dynamic range.

2210

8

we hope to see  
H. C. ...

10:12  
9:38